

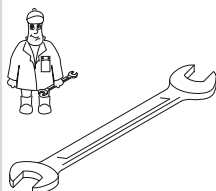

Gebr. Becker GmbH
Hölker Feld 29-31
D-42279 Wuppertal

Wartung
Maintenance
Entretien
Manutenzione
Mantenimiento



	Pos.	Menge Quantity Quantité Quantità Cantidad	Bestell-Nr. Ident No. No. Identification No. Identificazione No. de pedido	Bezeichnung Description Designation Designazione Descripción
DTLF / VTFL 2.200-2.250-2.360	...	1	549000 52200	Dichtungssatz, Complete set of seals, Jeu de joints, Kit di guarnizioni, Junta Completa
	108	SATZ (KIT)	901367 01005	Schieber, Rotor Vane, Palette, Silenciador
	108	SATZ (KIT)	901325 00005	" VTFL 2.360
	203	1	909512 00000	Filterpatrone, Filter cartridge, Cartouche Filtrante, Cartuccia filtro, Cartucho de filtro
	203	1	909596 00000	" (VTFL 2.200/6 + VTFL 2.250/6)
	412	0-2 ³⁾	909510 00000	Filterpatrone, Filter cartridge, Cartouche Filtrante, Cartuccia filtro, Cartucho de filtro
520	0-1 ³⁾	909541 00000	Filterpatrone, Filter cartridge, Cartouche Filtrante, Cartuccia filtro, Cartucho de filtro	

³⁾ variantenabhängig / variant-dependent / variante-dependantes / variante-dependenti / variante-dependientes



Ersatzteilliste
Spare parts list
Liste de pièces de rechange
Listino pezzi di ricambio
Lista de piezas de recambio
Lista de peças sobresselentes
Reserveonderdelenlijst
Reservedelsliste
Reservdelslista

Reservedelsliste
Varaosaluettelo
Wykaz części zamiennych
Seznam náhradních dílů
Tartalékalkatrész lista
Κατάλογος ανταλλακτικών
Перечень запасных частей
备用零件目录
スペアパーツリスト

DTLF / VTFL 2.200
DTLF / VTFL 2.250
VTFL 2.360
DVTFL 2.250



28000052200 07/2010

SERVICE

BECKER
D-42279 Wuppertal
www.becker-international.com

year

No.

type Option

frequency Hz

speed min⁻¹

power required kW

inlet capacity m³/h

max. vacuum mbar

Made in Germany

D Service:

Tel: +49 (0)202 697-171

Fax: +49 (0)202 64 44 74

E-Mail: info@becker-international.com

www.becker-international.com

Index	Pos.	Bestell Nr.	Beschreibung 
	□	549000 52200	DICHTUNGSSATZ ¹⁾
	2	05320052200	LATERNE
	3	01490052200	MOTORFLANSCH
	4	91830252200	HAUBE (VTLF)
	4	91830352200	HAUBE (DTLF)
	4	91830452200	HAUBE (DVTLF)
	5	92080052200	LUFTLEITHAUBE
	6	91830052200	HAUBE
	7	94532400000	INNENSECHSKANTSCHRAUBE, DIN912 M6X55
	8	95171000000	FEDERSCHEIBE
	9	94535100000	INNENSECHSKANTSCHRAUBE, DIN912 M10X35
	10	01140052200	DISTANZSTÜCK
	11	74130300000	GUMMI-PUFFER
	12	94527000000	WELLENENDSCHRAUBE
	13	94536300000	INNENSECHSKANTSCHRAUBE, DIN912 M6X40
	14	95160500000	RINGMUTTER, M16
	15	96070052200	LÜFTERHAUBE
	20	90180900000	INNENSECHSKANTSCHRAUBE, DIN912 M6X16
	24	54450222200	KUPPLUNGSHÄLFTE MIT VENTILATOR
	25	94940900000	UNTERLEGSCHEIBE
	27	90220020000	KUPPLUNGS-RING
	28	06490030200	ZENTRIERBUCHSE
	29	94523800000	SECHSKANTSCHRAUBE, DIN933 M10X35
	32	94693000000	STIFTSCHRAUBE, DIN939 M10X60
	33	95192500000	GUMMIFORMTEIL
	34	95035300000	KEGELPFANNE, DIN6319-12-G
	35	95035400000	KUGELSCHEIBE, DIN6319-10,5-C
	36	94523700000	SECHSKANTSCHRAUBE, DIN933 M10X30
	38	94696200000	STIFTSCHRAUBE, DIN939 M16X40
	52	74330300000	FETTPRESSE
	57	96705900000	HALTER
	101	00010052200	GEHÄUSE
	105	02000022200	KOLBEN
	105	02000051100	KOLBEN (VTLF 2.360)
	108	90136701005	KOHLESCHIEBER (SATZ)
	108	90132500005	KOHLESCHIEBER VTLF 2.360 (SATZ)
	110	94781200000	PASSFEDER, DIN6885 B10X8X50
	111	00070052200	SEITENDECKEL
	112	00080052200	SEITENDECKEL
	113	00110152200	LAGERDECKEL
	114	00100052200	LAGERDECKEL
	115	94532100000	INNENSECHSKANTSCHRAUBE, DIN912 M6X25
	116	94523000000	SECHSKANTSCHRAUBE, DIN933 M8X25
	117	94874200000	PASSKERBSTIFT, DIN1472 5X20
	119	95170300000	FEDERSCHEIBE, DIN137 A6
	121	06890091000	FETT-TRANSPORTRING
	124	90664900000	WÄLZLAGER
	125	90661720000	WÄLZLAGER
	127	91147700000	DISTANZSCHEIBE, 35X43X0,025
	128	91147800000	DISTANZSCHEIBE, 35X43X0,05
	129	91148000000	DISTANZSCHEIBE, 35X43X0,1
	132	90657700000	WELLENDICHTRING, DF45X62X7
	133	91131000000	DICHTUNGSSCHLAUCH, 45X2
	138	00310052200	DICHTUNG
	139	00810252200	SCHLAUCHTUELLE

DTLF / VTLF 2.200-2.250-2.360

Index	Pos.	Bestell Nr.	Beschreibung 
	201	04010052200	FILTERGEHÄUSE (VTLF+DVTLF)
	201	04010252200	FILTERGEHÄUSE (DTLF)
	203	90951200000	PATRONE (1x)
	207	94535000000	INNENSECHSKANTSCHRAUBE, DIN912 M10X30
	209	04020052200	FILTERDECKEL
	211	94691900000	STIFTSCHRAUBE, DIN939 M8X50
	213	94696800000	STIFTSCHRAUBE, DIN939 M8X70
	215	92150150000	HANDGRIFF
	217	00790022200	DICHTUNG
	218	00890052200	DICHTUNG
	219	00780052200	GEWINDEFLANSCH
	221	94533300000	INNENSECHSKANTSCHRAUBE, DIN912 M8X35
	225	94900100000	SCHMIERNIPPEL, DIN3405
	227	00810352200	SCHLAUCHTÜLLE
	228	74260152200	SCHMIERSCHLAUCH
	229	95200600000	SPANNHÜLSE
	230	04260010100	SCHLAUCH
	235	53500399619	RÜCKSCHLAGVENTIL - OPTIONAL
	236	02550052200	DICHTUNG
	238	94533600000	INNENSECHSKANTSCHRAUBE, DIN912 M8X50
	244	91280100000	GUMMIFORMTEIL
	301	04010152200	FILTERGEHÄUSE (VTLF)
	301	04010352200	FILTERGEHÄUSE (DTLF+DVTLF)
	313	04020152200	FILTERDECKE
	317	00030052200	DICHTUNG
	501	53980152200	SCHALLDÄMPFER
	504	94534600000	INNENSECHSKANTSCHRAUBE, DIN912 M8X140
	506	53500199619	ABBLASEVENTIL (VTLF)
	508	53400209619	DRUCKSICHERHEITSENTIL
	511	53400099619	VAKUUMSICHERHEITSENTIL
	515	73490099522	KAPPE - OPTIONAL
	520	90954100000	STAUBABSCHIEDER - OPTIONAL
	601	94694500000	STIFTSCHRAUBE, DIN939 M12X35
	603	94945500000	U-SCHEIBE, DIN7349
	605	94710700000	SECHSKANTMUTTER, DIN934 M12
	607	90210022200	MOTORKUPPLUNG, Ø 38mm (B5/300)
	607	90210122200	MOTORKUPPLUNG, Ø 42mm (5.5...11kW)
	607	90210222200	MOTORKUPPLUNG, Ø 48mm (15kW)
	608	00360052200	ZWISCHENFLANSCH (B5/300)
	609	94534900000	INNENSECHSKANTSCHRAUBE, DIN912 M10X25

DTLF / VTLF 2.200-2.250-2.360

¹⁾ Dichtungssatz - 54900052200 - Pos.: 133, 138, 217, 218, 317

OPTIONAL

VTLF	SK	Sonderausführung – mit Spülkühlung
DVTLF	(K)SK	“ “ “
VTLF	/6	Sonderausführung – Korrosionsschutz

Abweichende Positionen zum Standardgerät - siehe Anhang (Zeichnungsrückseite) 

Index	Pos.	Ident No.	Description 
	□	549000 52200	GASKET SET ¹⁾
2		05320052200	CONNECTION FLANGE
3		01490052200	MOTORFLANGE
4		91830252200	COVERING HOOD (VTLF)
4		91830352200	COVERING HOOD (DTLF)
4		91830452200	COVERING HOOD (DVTLF)
5		92080052200	AIR GUIDE COVER RING
6		91830052200	COVERING HOOD
7		94532400000	SOCKET HEAD SCREW
8		95171000000	SPRING DISC
9		94535100000	SOCKET HEAD SCREW
10		01140052200	DISTANCE-DISC
11		74130300000	RUBBER BUFFER
12		94527000000	SHAFT END BOLD
13		94536300000	SOCKET HEAD SCREW
14		95160500000	RING UNIT
15		96070052200	VENTILATOR HOOD
20		90180900000	SOCKET HEAD SCREW
24		54450222200	COUPLING WITH FAN
25		94940900000	WASHER
27		90220020000	COUPLING RING
28		06490030200	CENTRING BUSH
29		94523800000	HEX-HEAD SCREW
32		94693000000	STUD
33		95192500000	RUBBER ELEMENT
34		95035300000	DISHED WASHER
35		95035400000	SPHERICAL SEAT WASHER
36		94523700000	HEX-HEAD SCREW
38		94696200000	STUD
52		74330300000	GREASE PISTOL
57		96705900000	HOLDER
101		00010052200	PUMP BODY
105		02000022200	ROTOR
105		02000051100	ROTOR (VTLF 2.360)
108		90136701005	ROTOR VANES (KIT)
108		90132500005	ROTOR VANES VTLF 2.360 (KIT)
110		94781200000	KEY
111		00070052200	LID RIGHT
112		00080052200	LID LEFT
113		00110152200	BEARING COVER
114		00100052200	BEARING COVER
115		94532100000	SOCKET HEAD SCREW
116		94523000000	HEX-HEAD SCREW
117		94874200000	STRAIGHT PIN
119		95170300000	SPRING DISC
121		06890091000	GREASE DISTRIBUTION WASHER
124		90664900000	BALL BEARING
125		90661720000	BALL BEARING
127		91147700000	DISTANCE DISC
128		91147800000	DISTANCE DISC
129		91148000000	DISTANCE DISC
132		90657700000	SHAFT-SEALING RING
133		91131000000	SEAL
138		00310052200	GASKET
139		00810252200	CONDUIT-GREASE

DTLF / VTLF 2.200-2.250-2.360

Index	Pos.	Ident No.	Description 
201		04010052200	FILTER HOUSING (VTLF+DVTLF)
201		04010252200	FILTER HOUSING (DTLF)
203		90951200000	FILTER CARTRIDGE
207		94535000000	SOCKET HEAD SCREW
209		04020052200	FILTER COVER
211		94691900000	STUD
213		94696800000	STUD
215		92150150000	HANDLE
217		00790022200	GASKET
218		00890052200	GASKET
219		00780052200	CONNECTING FLANGE
221		94533300000	SOCKET HEAD SCREW
225		94900100000	GREASE NIPPLE
227		00810352200	HOSE CONNECTOR
228		74260152200	LUBRICATION LINE
229		95200600000	FIXING SLEEVE
230		04260010100	FLEXIBLE HOSE
235		53500399619	NON RETURN VALVE - OPTIONAL
236		02550052200	GASKET
238		94533600000	SOCKET HEAD SCREW
244		91280100000	RUBBER ELEMENT
301		04010152200	FILTER HOUSING (VTLF)
301		04010352200	FILTER HOUSING (DTLF+DVTLF)
313		04020152200	FILTER COVER
317		00030052200	GASKET
501		53980152200	SILENCER
504		94534600000	SOCKET HEAD SCREW
506		53500199619	BLOW-OFF VALVE
508		53400209619	PRESSURE RELIEF VALVE
511		53400099619	VACUUM RELIEF VALVE
515		73490099522	CAP - OPTIONAL
520		90954100000	DUST SEPARATOT - OPTIONAL
601		94694500000	STUD
603		94945500000	WASHER
605		94710700000	HEX. NUT
607		90210022200	COUPLING MOTOR SIDE, Ø 38mm (B5/300)
607		90210122200	COUPLING MOTOR SIDE, Ø 42mm (5.5...11kW)
607		90210222200	COUPLING MOTOR SIDE, Ø 48mm (15kW)
608		00360052200	INTERMEDIATE FLANGE (B5/300)
609		94534900000	SOCKET HEAD SCREW

DTLF / VTLF 2.200-2.250-2.360

¹⁾ Set of seals - 54900052200 - Pos.: 133, 138, 217, 218, 317

OPTIONAL	VTLF	SK	Special design – extra cooling
	DVTLF	(K)SK	“ “ “ “
	VTLF	/6	Special design – corrosion protection

Items different from standard appliance see appendix (back of drawing)

Index	Pos.	No. Identification	Designation
	□	549000 52200	JEU DE JOINTS ¹⁾
	2	05320052200	BRIDE DE RACCORDEMENT
	3	01490052200	BRIDE POUR MOTEUR
	4	91830252200	CARTER (VTLF)
	4	91830352200	CARTER (DTLF)
	4	91830452200	CARTER (DVTLF)
	5	92080052200	CAPOT DE CANALISATION DE L'AIR
	6	91830052200	CARTER
	7	94532400000	VIS HEXAGONALE INTERNE
	8	95171000000	DISQUE DE RESSORT
	9	94535100000	VIS HEXAGONALE INTERNE
	10	01140052200	DISQUE DE DISTANCE
	11	74130300000	AMORTISSEUR EN CAOUTCHOUC
	12	94527000000	VIS BOUT D'ARBRE
	13	94536300000	VIS HEXAGONALE INTERNE
	14	95160500000	ÉCROU À ANNEAU
	15	96070052200	CARTER DE VENTILATEUR
	20	90180900000	VIS HEXAGONALE INTERNE
	24	54450222200	ACCOUPLLEMENT AVEC VENTILATEUR
	25	94940900000	RONDELLE
	27	90220020000	DISQUE D'ACCOUPLLEMENT
	28	06490030200	BAGUE DE CENTRAGE
	29	94523800000	VIS HEXAGONALE
	32	94693000000	PRISONNIER
	33	95192500000	ELEMENT EN CAOUTCHOUC
	34	95035300000	RONDELLE À PORTÉE CONIQUE
	35	95035400000	RONDELLE À PORTÉE SPHÉRIQUE
	36	94523700000	VIS HEXAGONALE
	38	94696200000	TOURILLON
	52	74330300000	POMPE À GRAISSE
	57	96705900000	SUPPORT
	101	00010052200	CORP DE POMPE
	105	02000022200	PISTON
	105	02000051100	PISTON (VTLF 2.360)
	108	90136701005	PALETTE DE CHARBON (KIT)
	108	90132500005	PALETTE DE CHARBON VTLF 2.360 (KIT)
	110	94781200000	CLAVETTE
	111	00070052200	COUVERCLE A DROITE
	112	00080052200	COUVERCLE A GAUCHE
	113	00110152200	COUVERCLE DE ROULEMENT
	114	00100052200	COUVERCLE DE ROULEMENT
	115	94532100000	VIS HEXAGONALE INTERNE
	116	94523000000	VIS HEXAGONALE
	117	94874200000	GOUPILLE CYLINDRIQUE
	119	95170300000	DISQUE DE RESSORT
	121	06890091000	BAGUE DE TRANSPORT DE GRAISSE
	124	90664900000	ROULEMENT A BILLES
	125	90661720000	ROULEMENT A BILLES
	127	91147700000	DISQUE DE TOLERANCE
	128	91147800000	DISQUE AJUSTAGE
	129	91148000000	DISQUE AJUSTAGE
	132	90657700000	BAGUE D'ETANCHEITE
	133	91131000000	JOINT
	138	00310052200	JOINT
	139	00810252200	TUYEAU DE GRAISSAGE

DTLF / VTLF 2.200-2.250-2.360

Index	Pos.	No. Identification	Designation
	201	04010052200	BOITE POUR FILTRE (VTLF+DVTLF)
	201	04010252200	BOITE POUR FILTRE (DTLF)
	203	90951200000	CARTOUCHE FILTRANTE
	207	94535000000	VIS HEXAGONALE INTERNE
	209	04020052200	COUVERCLE DU FILTRE
	211	94691900000	PRISONNIER
	213	94696800000	PRISONNIER
	215	92150150000	POIGNEE
	217	00790022200	JOINT
	218	00890052200	JOINT
	219	00780052200	BOURRELET DE RACCORDEMENT
	221	94533300000	VIS HEXAGONALE INTERNE
	225	94900100000	GRAISSEUR
	227	00810352200	RACCORD À QUEUE CRANTÉE
	228	74260152200	CONDUITE DE GRAISSAGE
	229	95200600000	MANCHON DE FIXATION
	230	04260010100	TUYAUTERIE FLEXIBLE
	235	53500399619	SOUPAPE DE RETENUE - EN OPTION
	236	02550052200	JOINT
	238	94533600000	VIS HEXAGONALE INTERNE
	244	91280100000	ELEMENT EN CAOUTCHOUC
	301	04010152200	BOITE POUR FILTRE (VTLF)
	301	04010352200	BOITE POUR FILTRE (DTLF+DVTLF)
	313	04020152200	COUVERCLE DU FILTRE
	317	00030052200	JOINT
	501	53980152200	SILENCIEUX
	504	94534600000	VIS HEXAGONALE INTERNE
	506	53500199619	SOUPAPE D'ÉCHAPPEMENT
	508	53400209619	SOUPAPE DE SÉCURITÉ - PRESSION
	511	53400099619	SOUPAPE DE SÉCURITÉ - VIDE
	515	73490099522	CAPUCHON - EN OPTION
	520	90954100000	SÉPARATEUR DE LA POUSSIÈRE - EN OPTION
	601	94694500000	PRISONNIER
	603	94945500000	RONDELLE
	605	94710700000	ECROU A 6 PANS
	607	90210022200	ACCOUPLLEMENT MOTEUR, Ø 38mm (B5/300)
	607	90210122200	ACCOUPLLEMENT MOTEUR, Ø 42mm (5.5...11kW)
	607	90210222200	ACCOUPLLEMENT MOTEUR, Ø 48mm (15kW)
	608	00360052200	BRIDE INTERMÉDIAIRE (B5/300)
	609	94534900000	VIS HEXAGONALE INTERNE

DTLF / VTLF 2.200-2.250-2.360

¹⁾ Jeu de joints - 54900052200 - Pos.: 133, 138, 217, 218, 317

EN OPTION	VTLF	SK	Fabrication spéciale – refrigeration supplémentaire
	DVTLF	(K)SK	“ “ “ “
	VTLF	/6	Fabrication spéciale – protection contre la corrosion

Articles divergents vis-à-vis de l'appareil standard, voir annexe (dos du dessin / du plan)

Index	Pos.	No. Identificazione	Designazione 
	□	549000 52200	KIT GUARNIZIONI ¹⁾
	2	05320052200	FLANGIA DI RACCORDE
	3	01490052200	FLANGIA PER MOTORE
	4	91830252200	CARTER (VTLF)
	4	91830352200	CARTER (DTLF)
	4	91830452200	CARTER (DVTLF)
	5	92080052200	CONDOTTA ARIA
	6	91830052200	CARTER
	7	94532400000	VITE ESAGONALE INTERNA
	8	95171000000	DISCO A MOLLA
	9	94535100000	VITE ESAGONALE INTERNA
	10	01140052200	DISCO DISTANZA
	11	74130300000	AMMORTIZZATORE IN GOMMA
	12	94527000000	VITE DI CHIUSURA ALBERO
	13	94536300000	VITE ESAGONALE INTERNA
	14	95160500000	DADO AD OCCHIELLO
	15	96070052200	CARTER DEL VENTILATORE
	20	90180900000	VITE ESAGONALE INTERNA
	24	54450222200	GIUNTO CON VENTILATORE
	25	94940900000	RONDELLA
	27	90220020000	DISCO GIUNTO
	28	06490030200	BOCCOLA DI CENTRAGGIO
	29	94523800000	VITE ESAGONALE
	32	94693000000	L'ASTA A VITE
	33	95192500000	ELEMENTO IN GOMMA
	34	95035300000	BASE CONICA
	35	95035400000	RONDELLA CONICA
	36	94523700000	VITE ESAGONALE
	38	94696200000	VITE PRIGIONIERA
	52	74330300000	INGRASSATORE A PISTOLA
	57	96705900000	SUPPORTO
	101	00010052200	CARCASSA
	105	02000022200	ROTORE
	105	02000051100	ROTORE (VTLF 2.360)
	108	90136701005	PALETTE (KIT)
	108	90132500005	PALETTE VTLF 2.360 (KIT)
	110	94781200000	CHIAVETTA
	111	00070052200	COPERCHIO DESTRA
	112	00080052200	COPERCHIO SINISTRA
	113	00110152200	COPERCHIO CUSCINETTO
	114	00100052200	COPERCHIO CUSCINETTO
	115	94532100000	VITE ESAGONALE INTERNA
	116	94523000000	VITE ESAGONALE
	117	94874200000	PERNO
	119	95170300000	DISCO A MOLLA
	121	06890091000	ANELLO INGRASSAGGIO
	124	90664900000	CUSCINETTO A SFERA
	125	90661720000	CUSCINETTO A SFERA
	127	91147700000	DISCO A DISTANZA
	128	91147800000	DISCO GIUOCO
	129	91148000000	DISCO GIUOCO
	132	90657700000	GUARNIZIONE PER L'ALBERO
	133	91131000000	GUARNIZIONE
	138	00310052200	GUARNIZIONE
	139	00810252200	TUBETTO INGRASSATORE

DTLF / VTLF 2.200-2.250-2.360

Index	Pos.	No. Identificazione	Designazione 
	201	04010052200	CARCASSA DEL FILTRO (VTLF+DVTLF)
	201	04010252200	CARCASSA DEL FILTRO (DTLF)
	203	90951200000	CARTUCCIA FILTRO
	207	94535000000	VITE ESAGONALE INTERNA
	209	04020052200	COPERCHIO FILTRO
	211	94691900000	L'ASTA A VITE
	213	94696800000	L'ASTA A VITE
	215	92150150000	MANETTA
	217	00790022200	GUARNIZIONE
	218	00890052200	GUARNIZIONE
	219	00780052200	FLANGIA DI RACCORDO
	221	94533300000	VITE ESAGONALE INTERNA
	225	94900100000	RACCORDO DI LUBRIFICAZIONE
	227	00810352200	TUBO CONNETTORE
	228	74260152200	TUBAZIONE DI LUBRIFICAZIONE
	229	95200600000	MANICOTTO DI FISSAZIONE
	230	04260010100	TUBAZIONE FLESSIBILE
	235	53500399619	VALVOLA DI RITENUTA - OPTIONALE
	236	02550052200	GUARNIZIONE
	238	94533600000	VITE ESAGONALE INTERNA
	244	91280100000	ELEMENTO IN GOMMA
	301	04010152200	CARCASSA DEL FILTRO (VTLF)
	301	04010352200	CARCASSA DEL FILTRO (DTLF+DVTLF)
	313	04020152200	COPERCHIO FILTRO
	317	00030052200	GUARNIZIONE
	501	53980152200	SILENZIATORE
	504	94534600000	VITE ESAGONALE INTERNA
	506	53500199619	VALVOLA DI SFIATO
	508	53400209619	VALVOLA DI SICUREZZA - PRESSIONE
	511	53400099619	VALVOLA DI SICUREZZA - VUOTO
	515	73490099522	GUAINA - OPTIONALE
	520	90954100000	SEPARATORE DELLE POLVERI - OPTIONALE
	601	94694500000	L'ASTA A VITE
	603	94945500000	RONDELLA
	605	94710700000	DADO ESAGONALE
	607	90210022200	GIUNTO MOTORE, Ø 38mm (B5/300)
	607	90210122200	GIUNTO MOTORE, Ø 42mm (5.5...11kW)
	607	90210222200	GIUNTO MOTORE, Ø 48mm (15kW)
	608	00360052200	FLANGIA INTERMEDIA (B5/300)
	609	94534900000	VITE ESAGONALE INTERNA

DTLF / VTLF 2.200-2.250-2.360

¹⁾ Serie di guarnizione - 54900052200 - Pos.: 133, 138, 217, 218, 317

OPZIONALE

VTLF	SK	Modello speciale – refrigerazione supplementari
DVTLF	(K)SK	“ “ “ “
VTLF	/6	Modello speciale – protezione anti-corrosione

Vedere allegato (retro del disegno) per le posizioni divergenti dall'apparecchio standard 

DTLF / VTLF 2.200-2.250-2.360

Index	Pos.	No. De pedido	Descripción 
	□	549000 52200	JUEGO DE JUNTA ¹⁾
2		05320052200	FAROL
3		01490052200	BRIDA DE MOTOR
4		91830252200	CAPERUZA DE RECUBRIMIENTO (VTLF)
4		91830352200	CAPERUZA DE RECUBRIMIENTO (DTLF)
4		91830452200	CAPERUZA DE RECUBRIMIENTO (DVTFL)
5		92080052200	ANILLO CONDUCTOR DE AIRE
6		91830052200	CAPERUZA DE RECUBRIMIENTO
7		94532400000	TORNILLO HEXAGONAL INTERIOR
8		95171000000	ARANDELA ELÁSTICA
9		94535100000	TORNILLO HEXAGONAL INTERIOR
10		01140052200	PIEZA DISTANCIADORA
11		74130300000	AMORTIGUADOR DE GOMA
12		94527000000	TORNILLO TERMINAL DE ÁRBOL
13		94536300000	TORNILLO HEXAGONAL INTERIOR
14		95160500000	TUERCA M16
15		96070052200	CAPERUZA DE VENTILADOR
20		90180900000	TORNILLO HEXAGONAL INTERIOR
24		54450222200	MITAD DE ACOPLAMIENTO CON VENTILADOR
25		94940900000	ARANDELA
27		90220020000	DISCO DE ACOPLAMIENTO
28		06490030200	MANGUITO DE CENTRADO
29		94523800000	TORNILLO DE CABEZA HEXAGONAL
32		94693000000	ESPÁRRAGO
33		95192500000	PIEZA DE ORMA DE GOMA
34		95035300000	ANILLO CÓNICO FUERTE
35		95035400000	ARANDELA ESFÉRICA
36		94523700000	TORNILLO DE CABEZA HEXAGONAL
38		94696200000	ESPÁRRAGO
52		74330300000	PRENSA DE GRASA RELLENADO CON GRASA
57		96705900000	SOPORTE
101		00010052200	CARCASA
105		02000022200	ÉMBOLO
105		02000051100	ÉMBOLO (VTLF 2.360)
108		90136701005	DESPLAZADOR DE CARBÓN (KIT)
108		90132500005	DESPLAZADOR DE CARBÓN VTLF 2.360 (KIT)
110		94781200000	LENGÜETA DE AJUSTE
111		00070052200	TAPA LATERAL DERECHA
112		00080052200	TAPA LATERAL IZQUIERDA
113		00110152200	TAPA DE COJINETE
114		00100052200	TAPA DE COJINETE
115		94532100000	TORNILLO HEXAGONAL INTERIOR
116		94523000000	TORNILLO DE CABEZA HEXAGONAL
117		94874200000	PASADOR ENTALLADO DE AJUSTE
119		95170300000	ARANDELA ELÁSTICA
121		06890091000	ANILLO DE TRANSPORTE DE GRASA
124		90664900000	COJINETE DE RODAMIENTO
125		90661720000	COJINETE DE RODAMIENTO
127		91147700000	ARANDELA DE AJUSTE
128		91147800000	ARANDELA DISTANCIADORA
129		91148000000	ARANDELA DISTANCIADORA
132		90657700000	ANILLO DE JUNTA DE ÁRBOL
133		91131000000	MANGUERA DE JUNTA
138		00310052200	JUNTA
139		00810252200	TUBITO DE GRASA

Index	Pos.	No. De pedido	Descripción 
201		04010052200	CARCASA DE FILTRO (VTLF+DVTFL)
201		04010252200	CARCASA DE FILTRO (DTLF)
203		90951200000	CARTUCHO DE FILTRO
207		94535000000	TORNILLO HEXAGONAL INTERIOR
209		04020052200	TAPA DE FILTRO
211		94691900000	ESPÁRRAGO
213		94696800000	ESPÁRRAGO
215		92150150000	EMPUÑADURA
217		00790022200	JUNTA
218		00890052200	JUNTA
219		00780052200	BRIDA DE EMPALME
221		94533300000	TORNILLO HEXAGONAL INTERIOR
225		94900100000	BOQUILLA DE LUBRICACIÓN
227		00810352200	EMPALME DE EXTREMIDAD
228		74260152200	CONDUCTO DE ENGRASE
229		95200600000	MANGUITO DE FIJACIÓN
230		04260010100	MANGUERA
235		53500399619	VÁLVULA DE RETENCIÓN - OPCIONAL
236		02550052200	JUNTA
238		94533600000	TORNILLO HEXAGONAL INTERIOR
244		91280100000	PIEZA DE ORMA DE GOMA
301		04010152200	CARCASA DE FILTRO (VTLF)
301		04010352200	CARCASA DE FILTRO (DTLF+DVTFL)
313		04020152200	TAPA DE FILTRO
317		00030052200	JUNTA
501		53980152200	SILENCIADOR
504		94534600000	TORNILLO HEXAGONAL INTERIOR
506		53500199619	VÁLVULA DE ESCAPE
508		53400209619	VÁLVULA DE SEGURIDAD - PRESIÓN
511		53400099619	VÁLVULA DE SEGURIDAD - VACÍO
515		73490099522	TAPA - OPCIONAL
520		90954100000	SEPARADOR DE POLVO - OPCIONAL
601		94694500000	ESPÁRRAGO
603		94945500000	ARANDELA
605		94710700000	TUERCA HEXAGONAL
607		90210022200	ACOPAMIENTO DE MOTOR, Ø 38mm (B5/300)
607		90210122200	ACOPAMIENTO DE MOTOR, Ø 42mm (5.5...11kW)
607		90210222200	ACOPAMIENTO DE MOTOR, Ø 48mm (15kW)
608		00360052200	BRIDA INTERMEDIO (B5/300)
609		94534900000	TORNILLO HEXAGONAL INTERIOR

DTLF / VTLF 2.200-2.250-2.360

¹⁾ Junta completa - 54900052200 - Pos.: 133, 138, 217, 218, 317

OPCIONAL

VTLF	SK	Versión especial – refrigeración adicional
DVTFL	(K)SK	“ “ “ “
VTLF	/6	Versión especial – protección contra la corrosión

Para posiciones que derivan del aparato standard véase apéndice (lado trasero del plano) 

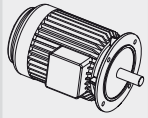

SERVICE ? i

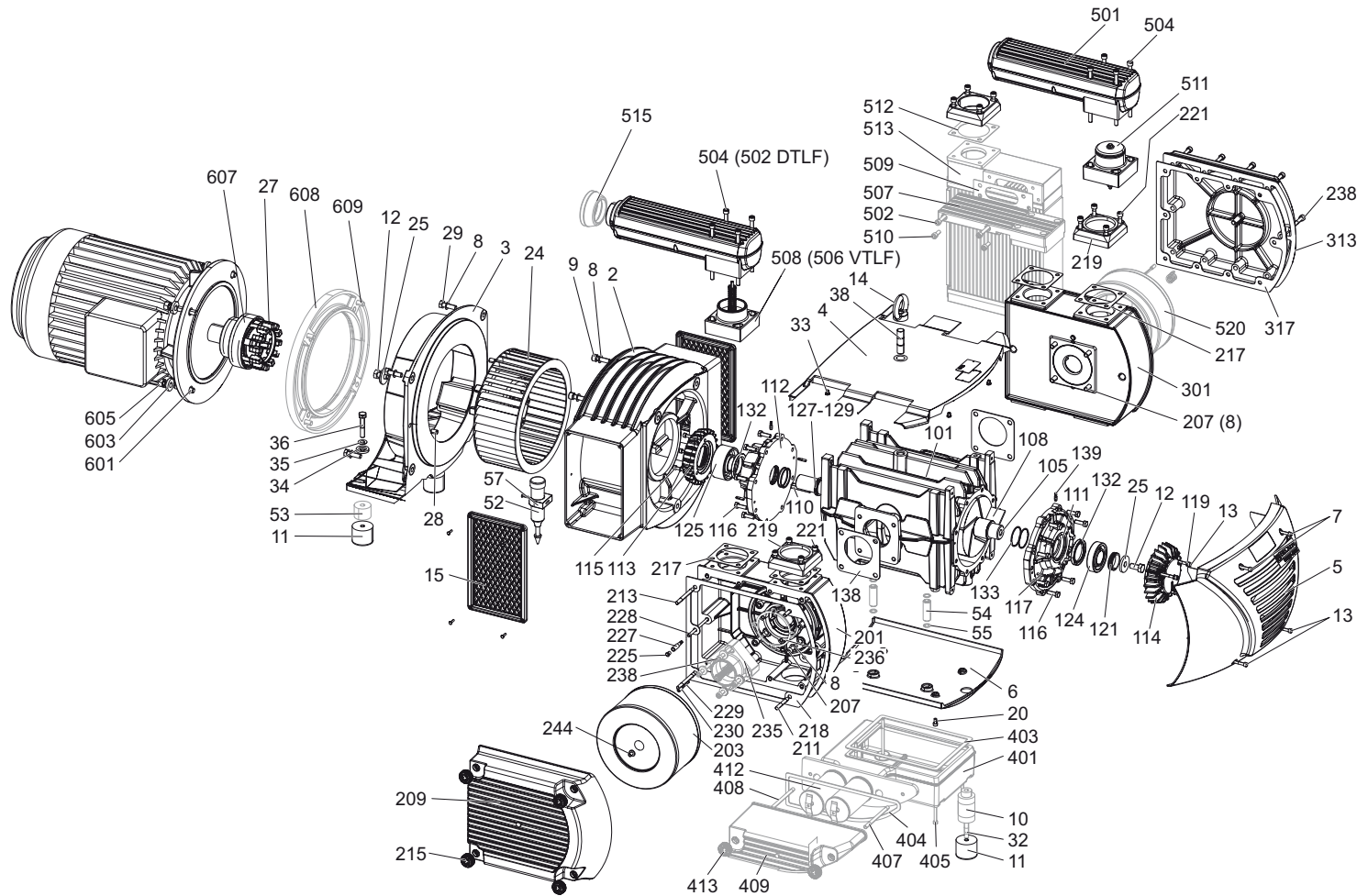
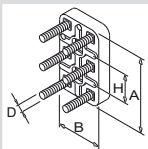
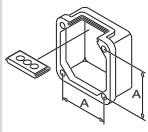
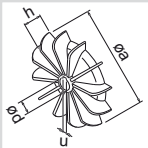
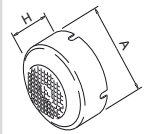



standard

DTLF 2.200
DTLF 2.250

VTLF 2.200
VTLF 2.250
VTLF 2.360

DVTLF 2.250

optional
en option
opcionale
opcional

optional en option optionale opcional 	Variante(n) Modifications Variantes	Pos ³⁾	Bestell Nr. / Ident No. / No. Identification / No. Identificazione / No. De pedido		Beschreibung / Description / Designation / Designazione / Descripcion
					
DTLF 2.200/XX DTLF 2.250/XX VTLF 2.200/XX VTLF 2.250/XX VTLF 2.360/XX DVTLF 2.250/XX	DTLF 2.250 K DVTLF 2.250 K	502	945345 00000		INNENSECHSKANTSCHRAUBE / SOCKET HEAD SCREW / VIS HEXAGONALE INTERNE / VITE ESAGONALE INTERNA / TORNILLO HEXAGONAL INTERIOR ANSCHLUSSSTÜCK DICHTUNG / GASKET / JOINT / GUARNIZIONE / JUNTA INNENSECHSKANTSCHRAUBE / SOCKET HEAD SCREW / VIS HEXAGONALE INTERNE / VITE ESAGONALE INTERNA / TORNILLO HEXAGONAL INTERIOR DICHTUNG / GASKET / JOINT / GUARNIZIONE / JUNTA KÜHLER / COOLER / REFROIDISSEUR / RAFFREDDATORE / REFRIGERADOR
		507	060301 52200		
		509	008903 22200		
		510	945330 04000		
		512	007900 22200		
		513	560201 22200		
	VTLF 2.250 SK	10	011401 52200	011400-52200	Distanzscheibe / Distance-Disk / Disque Ajustage / Disco Distancia / Arandela Distanciadora STIFTSCHRAUBE / STUD / PRISONNIER / L'ASTA A VITE / ESPÁRAGO SECHSKANTSCHRAUBE / HEX-HEAD SCREW / VIS HEXAGONALE / VITE ESAGONALE / TORNILLO DE CABEZA HEXAGONAL Distanzscheibe / Distance-Disk / Disque Ajustage / Disco Distancia / Arandela Distanciadora Distanzscheibe / Distance-Disk / Disque Ajustage / Disco Distancia / Arandela Distanciadora DICHTUNG / GASKET / JOINT / GUARNIZIONE / JUNTA FILTERGEHÄUSE / FILTER HOUSING / BOITE POUR FILTRE / CONTENITORE FILTRO / CARCASA DE FILTRO DICHTUNG / GASKET / JOINT / GUARNIZIONE / JUNTA DICHTUNG / GASKET / JOINT / GUARNIZIONE / JUNTA INNENSECHSKANTSCHRAUBE / SOCKET HEAD SCREW / VIS HEXAGONALE INTERNE / VITE ESAGONALE INTERNA / TORNILLO HEXAGONAL INTERIOR STIFTSCHRAUBE / STUD / PRISONNIER / L'ASTA A VITE / ESPÁRAGO STIFTSCHRAUBE / STUD / PRISONNIER / L'ASTA A VITE / ESPÁRAGO DECKEL / COVER / COUVERCLE / COPERCHIO / TAPA FILTERPATRONE / FILTER CARTRIDGE / CARTOUCHE FILTRANTE / CARTUCCIA FILTRO / CARTUCHO DE FILTRO HANDGRIFF / HANDLE / POIGNEE / MANETTA / EMPUÑADURA
		32	946969 00000	946930-00000	
		36	945129 00000	945237-00000	
		53	011400 22200		
		54	011402 52200		
		55	913110 01000		
		401	004600 52200		
		403	008901 52200		
		404	008902 52200		
405		945376 00000			
407		946973 00000			
408		946975 00000			
409		040203 52200			
412		909510 00000			
413	921501 50000				
DVTLF 2.250 KSK	502	945345 00000		INNENSECHSKANTSCHRAUBE / SOCKET HEAD SCREW / VIS HEXAGONALE INTERNE / VITE ESAGONALE INTERNA / TORNILLO HEXAGONAL INTERIOR ANSCHLUSSSTÜCK DICHTUNG / GASKET / JOINT / GUARNIZIONE / JUNTA INNENSECHSKANTSCHRAUBE / SOCKET HEAD SCREW / VIS HEXAGONALE INTERNE / VITE ESAGONALE INTERNA / TORNILLO HEXAGONAL INTERIOR DICHTUNG / GASKET / JOINT / GUARNIZIONE / JUNTA KÜHLER / COOLER / REFROIDISSEUR / RAFFREDDATORE / REFRIGERADOR	
	507	060301 52200			
	509	008903 22200			
	510	945330 04000			
	512	007900 22200			
	513	560201 22200			
VTLF 2.200/6 VTLF 2.250/6	101	000111 52200	000100-52200	GEHÄUSE / PUMP BODY / CORP DE POMPE / CARCASSA / CARCASA KOLBEN / ROTOR / PISTON / ROTORE / ÉMBOLO SEITENDECKEL / LID LATERAL / COUVERCLE LATÉRAL / COPERCHIO LATERALE / TAPA LATERAL SEITENDECKEL / LID LATERAL / COUVERCLE LATÉRAL / COPERCHIO LATERALE / TAPA LATERAL SEITENDECKEL / LID LATERAL / COUVERCLE LATÉRAL / COPERCHIO LATERALE / TAPA LATERAL FILTERPATRONE / FILTER CARTRIDGE / CARTOUCHE FILTRANTE / CARTUCCIA FILTRO / CARTUCHO DE FILTRO	
	105	020011 22200	020000-22200		
	111	000711 52200	000700-52200		
	112	000811 52200	000800-52200		
	203	909596 00000	909542-00000		

³⁾ variantenabhängige Bauteile / variant-dependent components / composants variante-dependantes / componenti variante-dipendenti / componentes variante-dependientes